

MAGNES MAGNET МАГНИТ



ZASTOSOWANIE / APPLICATION / ПРИМЕНЕНИЕ



PARAMETRY / CHARACTERISTICS / ХАРАКТЕРИСТИКИ





PAKOWANIE / PACKING / УПАКОВКА

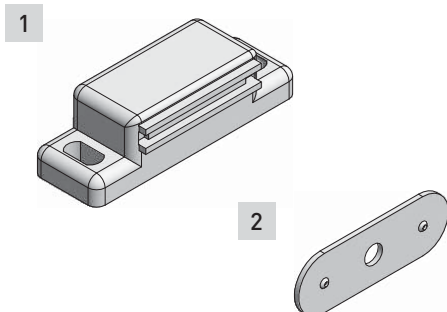

SKŁAD ZESTAWU / SET INCLUDES / КОМПЛЕКТАЦИЯ



1. Magnes / magnet / магнит
2. Blaszka / lamina / пластина

	
MG-MENSA-010	biały white белый
MG-MENSA-030	brązowy brown коричневый

PLANOWANIE / PLANNING / ПРОЕКТИРОВАНИЕ

Wymiary zabudowy
Cabinet planning information
Размер установки

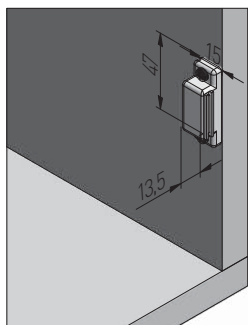

Szczelina frontu
Front gap
Зазор фасада

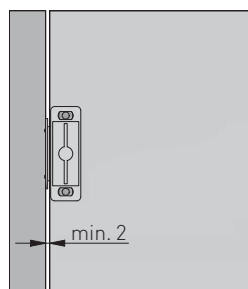

Rozstaw otworów montażowych w korpusie
Spacing of mounting holes in the body
Расстояние между монтажными отверстиями в корпусе

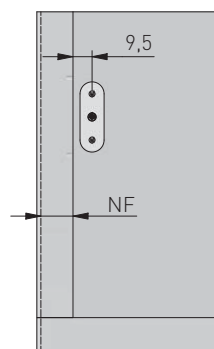
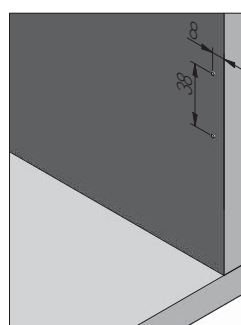

NF – nalożenie frontu
front overlap
наложение фасада

Wymiary produktu
Product dimensions
Размеры продукта

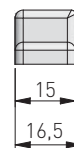
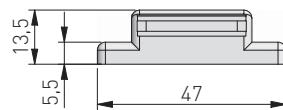
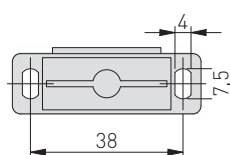
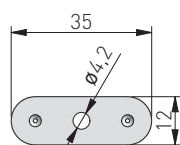

MONTAŻ / ASSEMBLY / УСТАНОВКА

